



SPARE PARTS LIST

CHAIN SAWS

340 EPA, 2004-03

Q Tillbehör
Accessories
Zubehöre
Accessoires
Accesorios

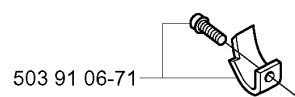
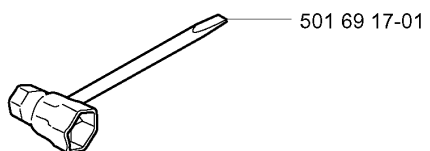

Winter kit
*compl 537 04 28-02

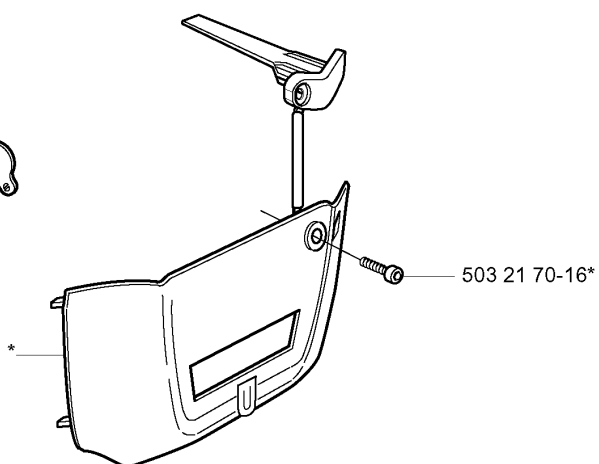
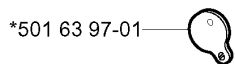

ACCESSORIES

340 EPA, 2004-03

Part No	Description	Remark	QTY KIT
501 63 97-01	COVER		1
501 69 17-01	COMBINATION WRENCH		1
503 21 70-16	SCREW CCRPANT		1
503 91 06-71	KIT		1
537 04 28-02	KIT	WINTER KIT	1

G

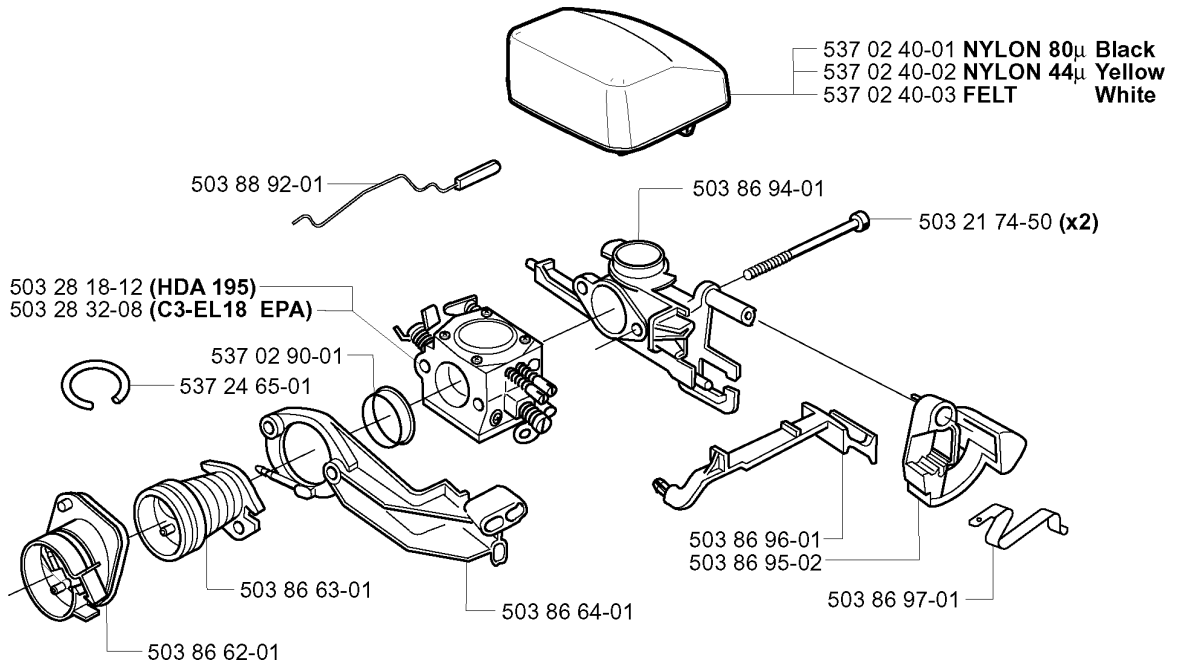

CARBURETOR & AIR FILTER

340 EPA, 2004-03

Part No	Description	Remark	QTY KIT
503 21 74-50	SCREW IHSCCT		2
503 28 18-12	CARBURETTOR	HDA 195	1
503 28 32-08	CARBURETTOR	C3-EL18 EPA	1
503 86 62-01	INSULATION WALL		1
503 86 63-01	BELLOWS		1
503 86 64-01	FLANGE		1
503 86 94-01	INLET BEND		1
503 86 95-02	STOP CONTROL		1
503 86 96-01	CHOKE CONTROL		1
503 86 97-01	SHORT CIRCUIT SPRING		1
503 88 92-01	THROTTLE WIRE ASSY		1
537 02 40-01	AIR FILTER	NYLON BLACK	1
537 02 40-02	AIR FILTER	NYLON YELLOW	1
537 02 40-03	AIR FILTER	FELT WHITE	1
537 02 90-01	SUPPORT RING		1
537 24 65-01	IMPULSE HOSE		1

N compl 503 28 18-12 Walbro HDA 195

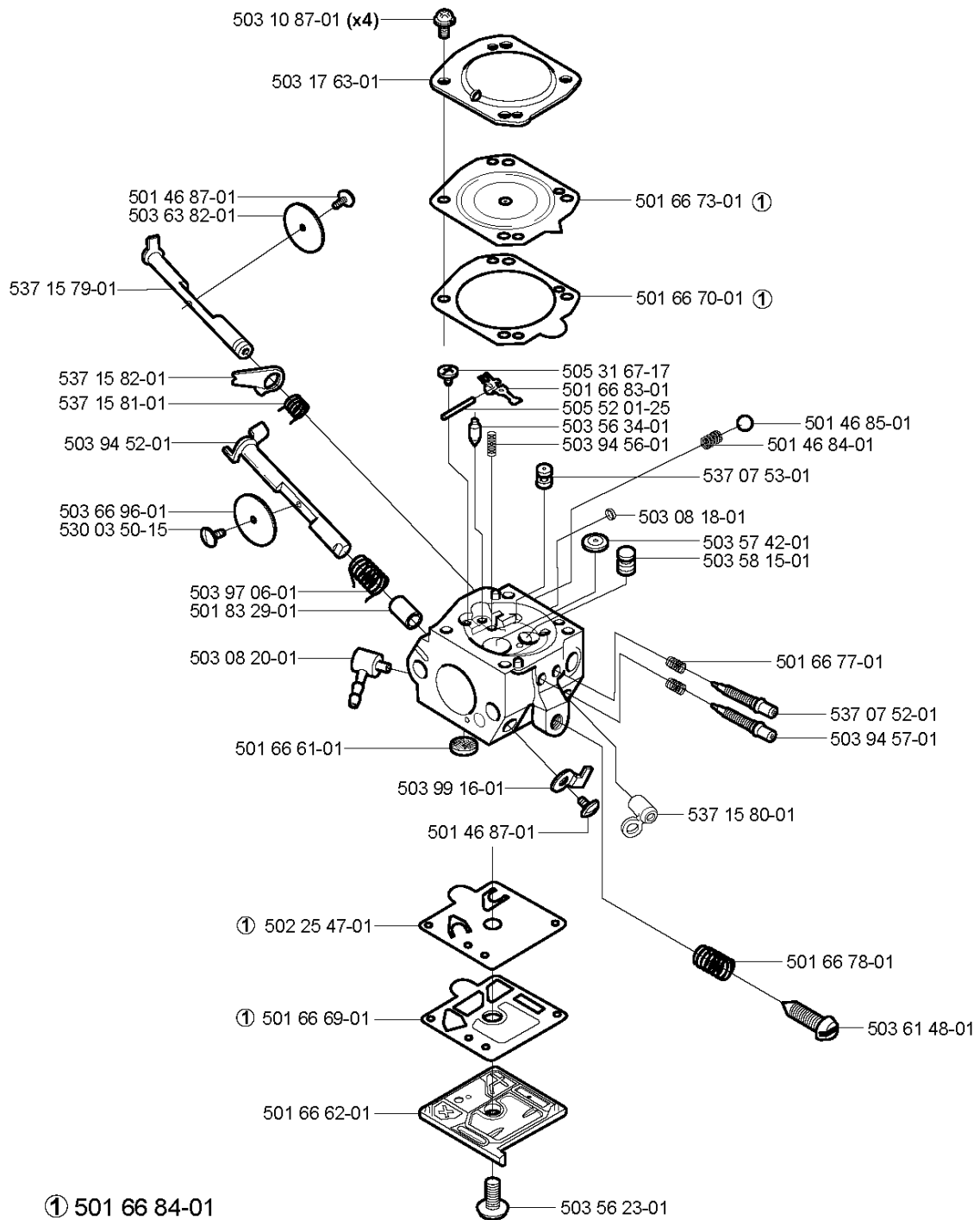

① 501 66 84-01
Set of gaskets
Dichtungssatz
Jeu de joints
Juego de juntas
Packningssats

CARBURETOR DETAILS

340 EPA, 2004-03

Part No	Description	Remark	QTY KIT
501 46 84-01	SPRING		1
501 46 85-01	BALL-CHOKE FRICTION		1
501 46 87-01	SCREW		1
501 46 87-01	SCREW		1
501 66 61-01	SCREEN-INLET		1
501 66 62-01	COVER PUMP		1
501 66 69-01	GASKET	501 66 84-01 SET OF GASKETS	1
501 66 70-01	GASKET	501 66 84-01 SET OF GASKETS	1
501 66 73-01	DIAPH-ASS'Y METERING	501 66 84-01 SET OF GASKETS	1
501 66 77-01	SPRING		1
501 66 78-01	SPRING		1
501 66 83-01	LEVER-METERING		1
501 66 84-01	GASKET KIT		1
501 83 29-01	BUSHING		1
502 25 47-01	DIAPHRAGM PUMP	501 66 84-01 SET OF GASKETS	1
503 08 18-01	PLUG-WELCH		1
503 08 20-01	FITTING-FUEL INLET		1
503 10 87-01	SCREW		4
503 17 63-01	COVER		1
503 28 18-12	CARBURETTOR	WALBRO HDA 195	1
503 56 23-01	SCREW		1
503 56 34-01	VALVE INLET NEEDLE		1
503 57 42-01	PLUG-WELCH		1
503 58 15-01	NOZZLE ASS'Y		1
503 61 48-01	SCREW		1
503 63 82-01	VALVE CHOKE		1
503 66 96-01	VALVE THROTTLE		1
503 94 52-01	SHAFT ASSY		1
503 94 56-01	SPRING		1
503 94 57-01	NEEDLE		1
503 97 06-01	SPRING		1
503 99 16-01	LEVER		1
505 31 67-17	SCREW		1
505 52 01-25	PIN-METERING LEVER		1
530 03 50-15	SCREW		1
537 07 52-01	NEEDLE		1
537 07 53-01	JET		1
537 15 79-01	SHAFT ASSY		1
537 15 80-01	LEVER		1
537 15 81-01	SPRING		1
537 15 82-01	LEVER		1

P *compl 503 28 32-08 ZAMA C3-EL18 (EPA)

ZAMA C3-EL18

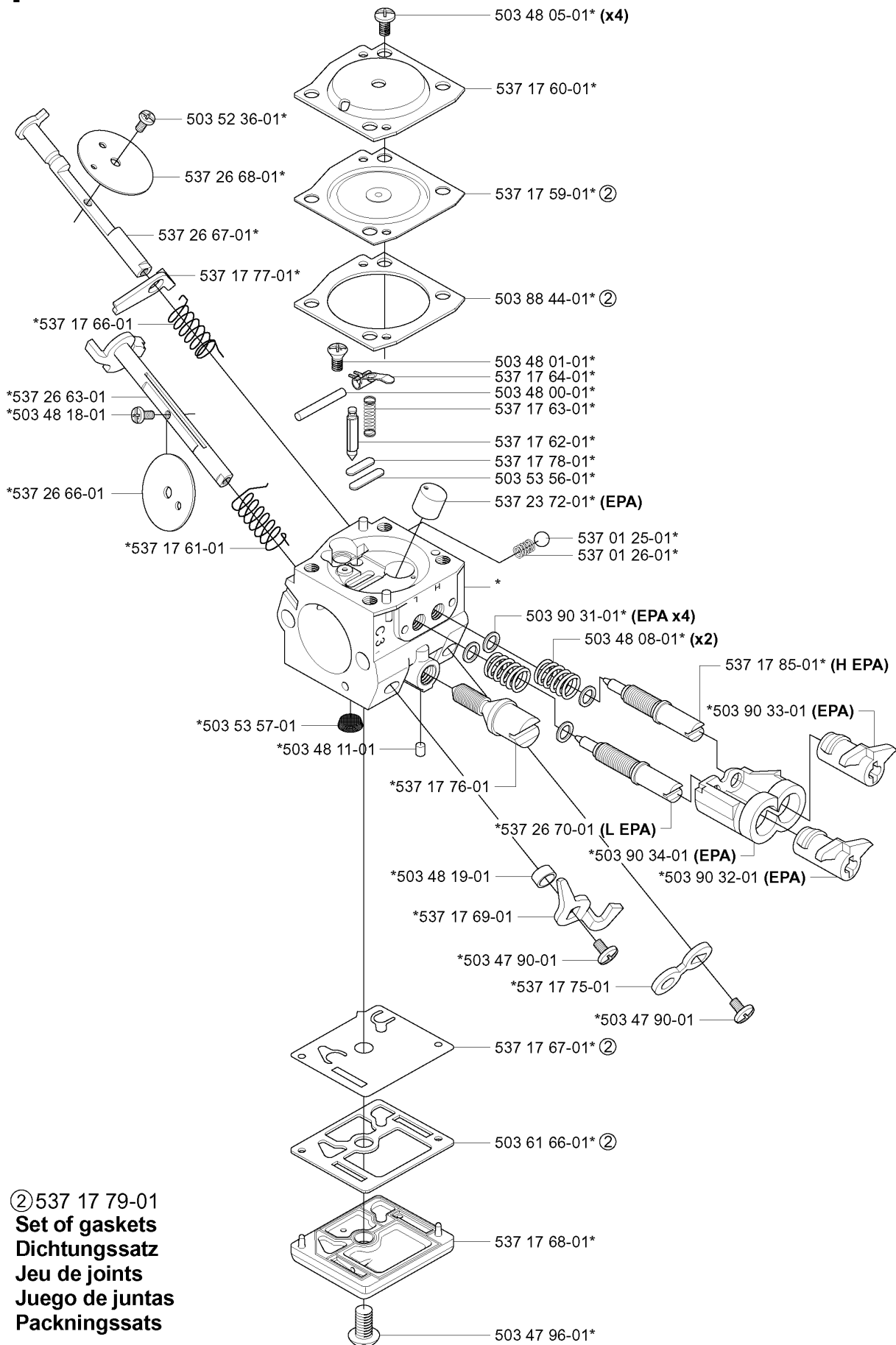

② 537 17 79-01
Set of gaskets
Dichtungssatz
Jeu de joints
Juego de juntas
Packningssats

CARBURETOR DETAILS

340 EPA, 2004-03

Part No	Description	Remark	QTY KIT
503 28 32-08	CARBURETTOR	ZAMA C3-EL18 (EPA)	1
503 47 90-01	SCREW		1
503 47 90-01	SCREW		1
503 47 96-01	SCREW		1
503 48 00-01	PIN RETAINING SCREW		1
503 48 01-01	SCREW		1
503 48 05-01	SCREW		4
503 48 08-01	SPRING		2
503 48 11-01	PIECE		1
503 48 18-01	SCREW		1
503 48 19-01	COLLAR		1
503 52 36-01	SCREW		1
503 53 56-01	PLUG WELCH		1
503 53 57-01	STRAINER		1
503 61 66-01	GASKET PUMP	537 17 79-01 SET OF GASKETS	1
503 88 44-01	GASKET	537 17 79-01 SET OF GASKETS	1
503 90 31-01	WASHER	EPA	4
503 90 32-01	LIMITER CAP	EPA	1
503 90 33-01	LIMITER CAP	EPA	1
503 90 34-01	RETAINER	EPA	1
537 01 25-01	BALL		1
537 01 26-01	SPRING		1
537 17 59-01	DIAPHRAGM	537 17 79-01 SET OF GASKETS	1
537 17 60-01	COVER		1
537 17 61-01	SPRING		1
537 17 62-01	VALVE		1
537 17 63-01	SPRING		1
537 17 64-01	LEVER		1
537 17 66-01	SPRING		1
537 17 67-01	DIAPHRAGM	537 17 79-01 SET OF GASKETS	1
537 17 68-01	COVER		1
537 17 69-01	LEVER		1
537 17 75-01	LEVER		1
537 17 76-01	SCREW		1
537 17 77-01	LEVER		1
537 17 78-01	PLUG		1
537 17 79-01	GASKET KIT		1
537 17 85-01	SCREW	H EPA	1
537 23 72-01	NOZZLE ASSY	EPA	1
537 26 63-01	SHAFT ASSY		1
537 26 66-01	VALVE		1
537 26 67-01	SHAFT ASSY		1
537 26 68-01	VALVE		1
537 26 70-01	SCREW	L EPA	1

A

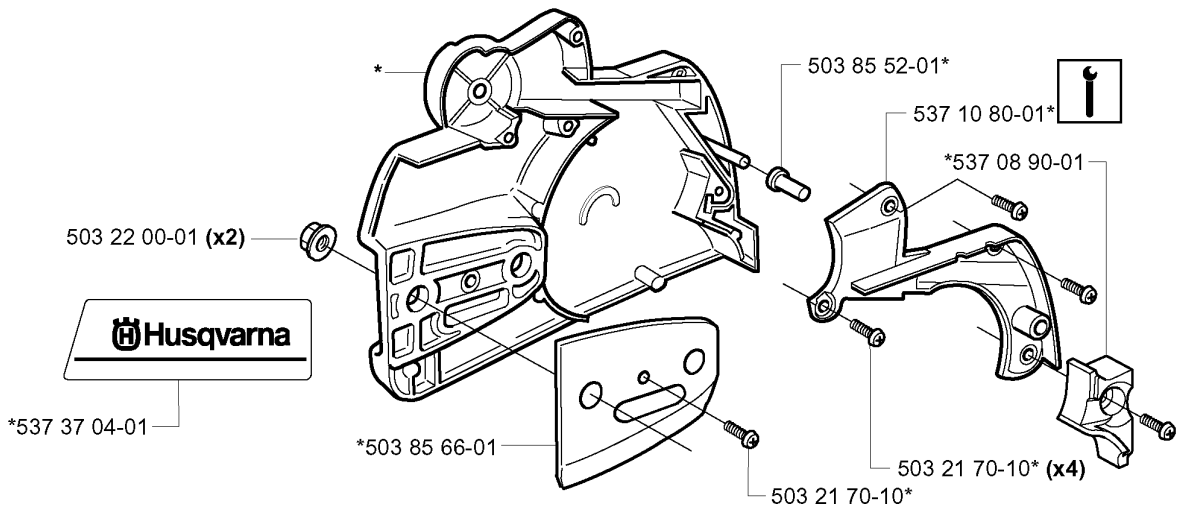
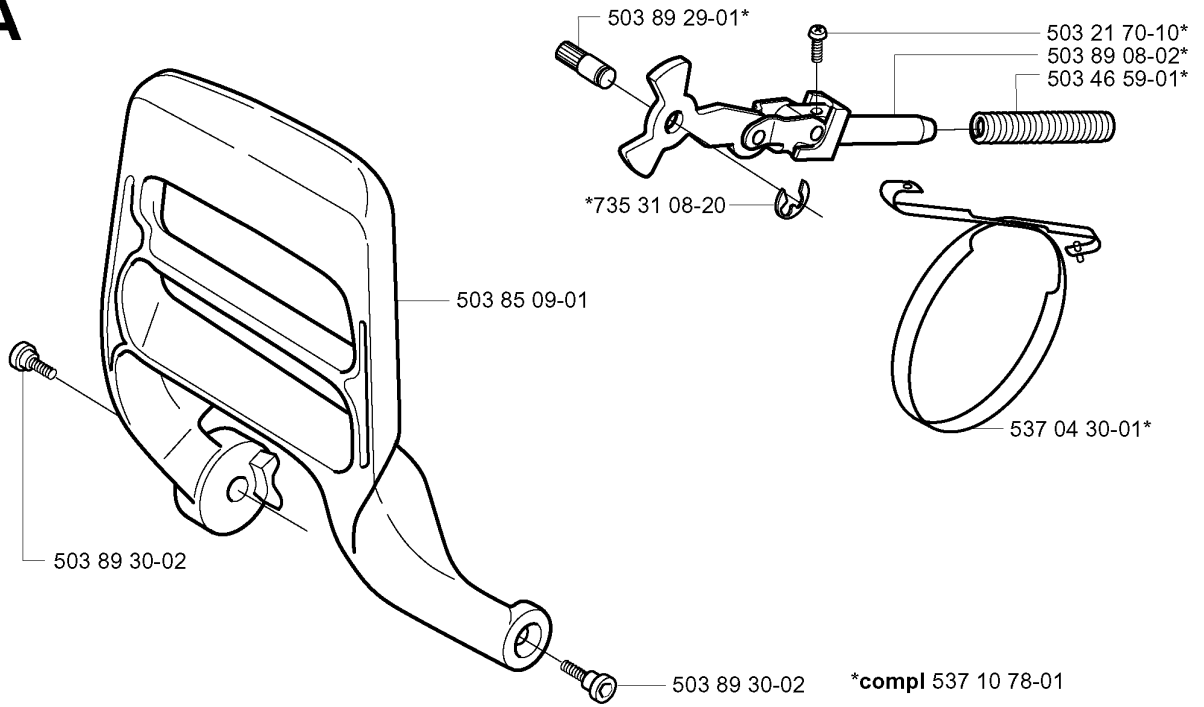

CHAIN BRAKE

340 EPA, 2004-03

Part No	Description	Remark	QTY KIT
503 21 70-10	SCREW CCRPANT		1
503 21 70-10	SCREW CCRPANT		4
503 21 70-10	SCREW CCRPANT		1
503 22 00-01	HEXAGON NUT FLANGE		2
503 46 59-01	BRAKE SPRING		1
503 85 09-01	HAND GUARD		1
503 85 52-01	GUIDE BUSHING		1
503 85 66-01	COVER PLATE		1
503 89 08-02	KNEE JOINT ASSY		1
503 89 29-01	PIN KNEE-JOINT		1
503 89 30-02	SCREW		1
503 89 30-02	SCREW		1
537 04 30-01	BRAKE BAND ASSY		1
537 08 90-01	WEAR PROTECTION		1
537 10 78-01	CHAIN BRAKE		1
537 10 80-01	HUB CAP		1
537 37 04-01	LABEL		1
735 31 08-20	E-CLIP		1

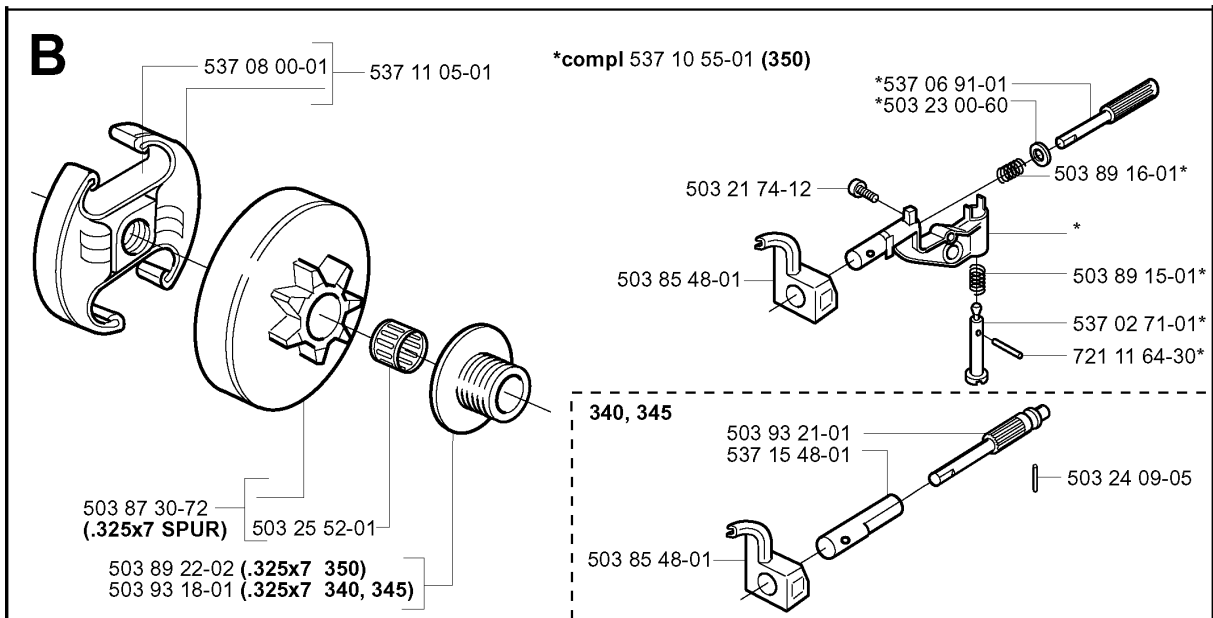

CLUTCH & OIL PUMP

340 EPA, 2004-03

Part No	Description	Remark	QTY KIT
503 21 74-12	SCREW IHSCT		1
503 23 00-60	WASHER		1
503 24 09-05	NEEDLE ROLLER		1
503 25 52-01	NEEDLE BEARING		1
503 85 48-01	SEALING		1
503 85 48-01	SEALING		1
503 87 30-72	CLUTCH DRUM	.325X7 SPUR	1
503 89 15-01	SPRING		1
503 89 16-01	SPRING		1
503 89 22-02	PUMP PINION	.325X7 350	1
503 93 18-01	PUMP PINION	.325X7 340, 345	1
503 93 21-01	PUMP PISTON		1
537 02 71-01	ADJUSTER		1
537 06 91-01	PUMP PISTON		1
537 08 00-01	CLUTCH SPRING		1
537 10 55-01	OIL PUMP	350	1
537 11 05-01	CLUTCH ASSY		1
537 15 48-01	PUMP CYLINDER		1
721 11 64-30	GROOVED PIN		1

C *compl 503 91 05-01

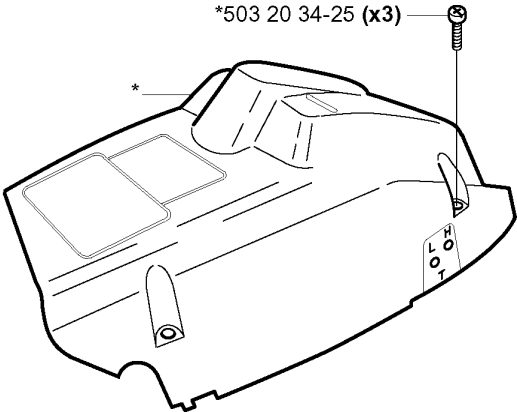
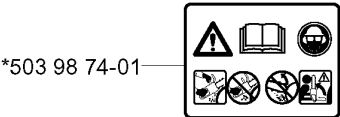

COVER

340 EPA, 2004-03

Part No	Description	Remark	QTY KIT
503 20 34-25	SCREW CRPANMO		3
503 91 05-01	CYLINDER COVER ASSY		1
503 98 74-01	LABEL		1

H *compl 537 17 20-01

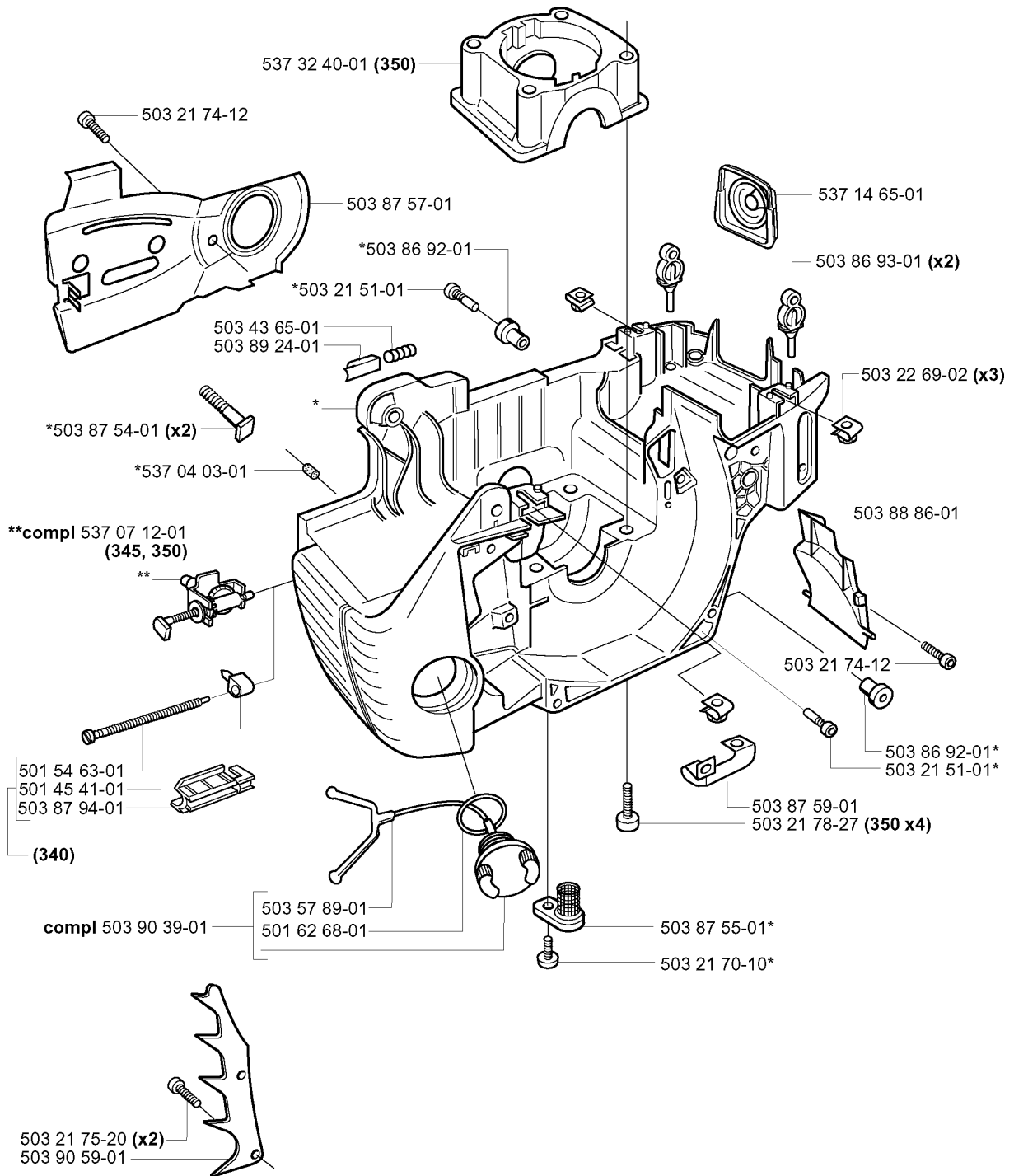

CRANKCASE

340 EPA, 2004-03

Part No	Description	Remark	QTY KIT
501 45 41-01	NUT	340	1
501 54 63-01	CHAIN TENSION SCREW	340	1
501 62 68-01	GASKET		1
503 21 51-01	SCREW IHSCFT		1
503 21 51-01	SCREW IHSCFT		1
503 21 70-10	SCREW CCRPANT		1
503 21 74-12	SCREW IHSCFT		1
503 21 74-12	SCREW IHSCFT		1
503 21 75-20	SCREW IHSCFT		2
503 21 78-27	SCREW IHSCFT	350	4
503 22 69-02	NUT		3
503 43 65-01	POSITION SPRING		1
503 57 89-01	HOLDER		1
503 86 92-01	LATERAL SUPPORT		1
503 86 92-01	LATERAL SUPPORT		1
503 86 93-01	CARBURETTOR MOUNTING		2
503 87 54-01	BAR BOLT		2
503 87 55-01	OIL SCREEN		1
503 87 57-01	CHAIN GUIDE PLATE		1
503 87 59-01	GROUND PLATE		1
503 87 94-01	RETAINER	340	1
503 88 86-01	AIR NOZZLE		1
503 89 24-01	LOCK		1
503 90 39-01	TANK CAP		1
503 90 59-01	BARKSTØD		1
537 04 03-01	VALVE		1
537 07 12-01	CHAIN TENSIONER	345, 350	1
537 14 65-01	BELLOWS		1
537 17 20-01	CRANKCASE ASSY		1
537 32 40-01	BEARING COVER	350	1

E *compl 503 85 80-71

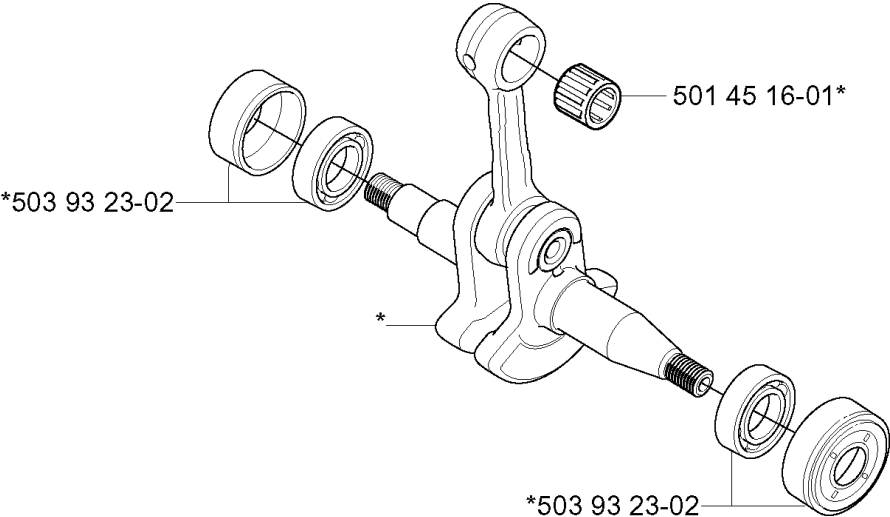

CRANKSHAFT

340 EPA, 2004-03

Part No	Description	Remark	QTY KIT
501 45 16-01	NEEDLE BEARING		1
503 85 80-71	CRANKSHAFT		1
503 93 23-02	BEARING CAGE		1
503 93 23-02	BEARING CAGE		1

D *compl 503 87 00-76 (340)
*compl 503 87 02-76 (345)

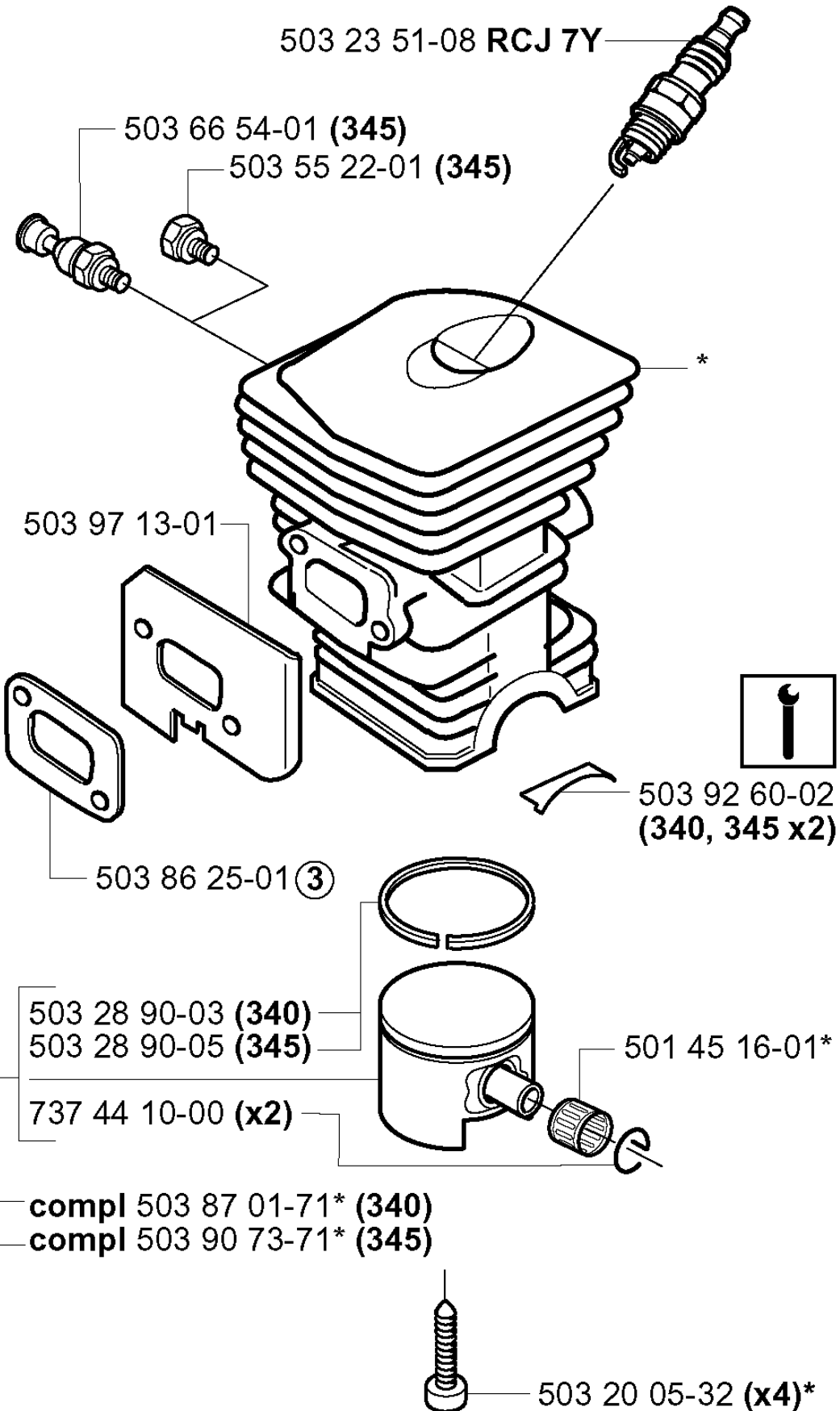

CYLINDER PISTON

340 EPA, 2004-03

Part No	Description	Remark	QTY KIT
501 45 16-01	NEEDLE BEARING		1
503 20 05-32	SCREW IHSCM		4
503 23 51-08	SPARK PLUG	RCJ 7Y	1
503 28 90-03	PISTON RING	340	1
503 28 90-05	PISTON RING	345	1
503 28 90-10	PISTON RING		1
503 28 90-11	PISTON RING		1
503 55 22-01	PLUG	345	1
503 66 54-01	DECOMPRESSION VALVE	345	1
503 86 25-01	GASKET		1
503 86 99-71	CYLINDER ASSY		1
503 87 00-76	CYLINDER ASSY	340	1
503 87 01-71	PISTON ASSY	340	1
503 87 02-76	CYLINDER ASSY	345	1
503 89 44-01	GASKET		1
503 89 96-71	PISTON ASSY		1
503 90 73-71	PISTON ASSY	345	1
503 92 60-02	COVER PLATE	340, 345	2
503 97 13-01	HEAT DEFLECTOR		1
537 09 98-01	HEAT DEFLECTOR		1
537 22 34-02	PISTON ASSY		1
537 25 30-02	CYLINDER ASSY		1
725 53 33-55	SCREW IHSCM		1
737 44 10-00	SNAP RING		2

J *compl 503 86 37-71

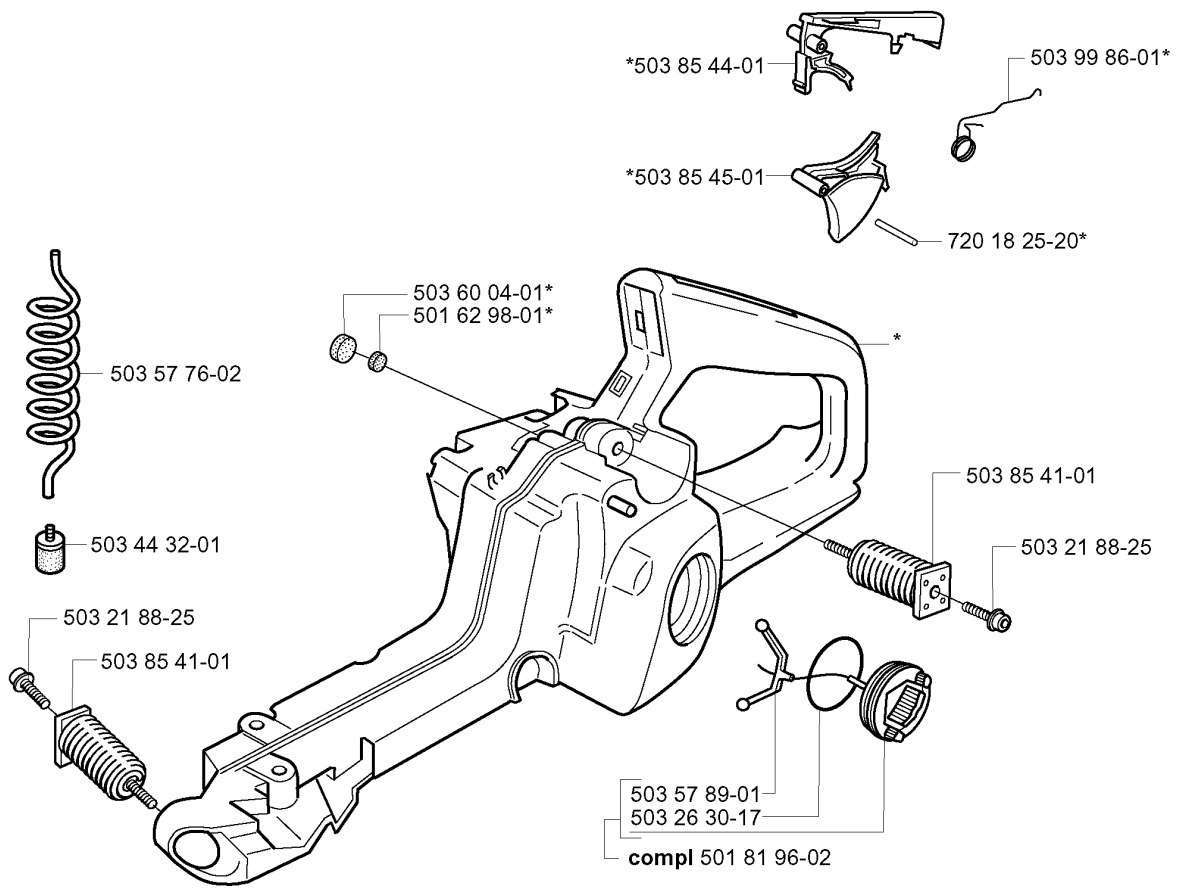

FUEL TANK

340 EPA, 2004-03

Part No	Description	Remark	QTY KIT
501 62 98-01	VALVE PLUG		1
501 81 96-02	TANK CAP ASSY		1
503 21 88-25	SCREW IHSCFT		1
503 21 88-25	SCREW IHSCFT		1
503 26 30-17	O-RING		1
503 44 32-01	FILTER		1
503 57 76-02	FUEL HOSE		1
503 57 89-01	HOLDER		1
503 60 04-01	FILTER PLUG		1
503 85 41-01	ANTIVIBRATION ELEMENT		1
503 85 41-01	ANTIVIBRATION ELEMENT		1
503 85 44-01	THROTTLE LOCKOUT		1
503 85 45-01	THROTTLE TRIGGER		1
503 86 37-71	FUEL TANK		1
503 99 86-01	RECOIL SPRING		1
720 18 25-20	PARALLEL PIN		1

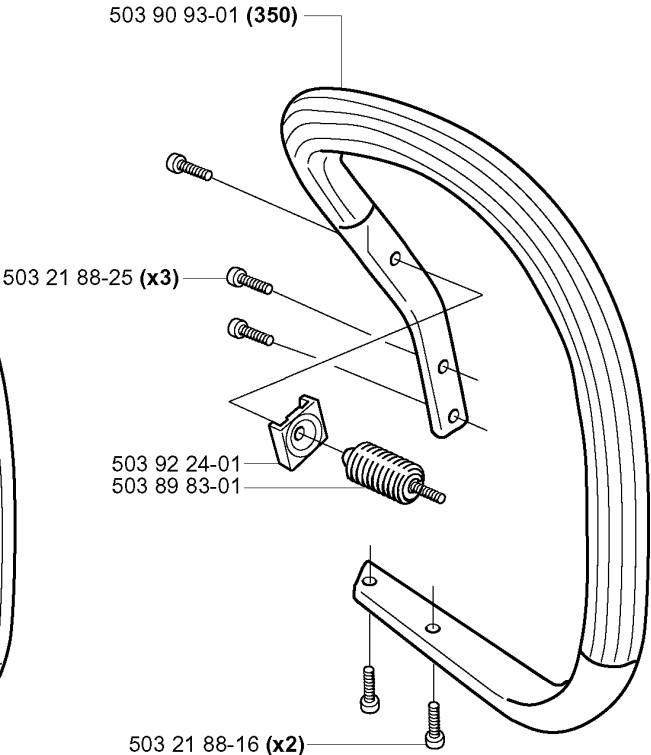
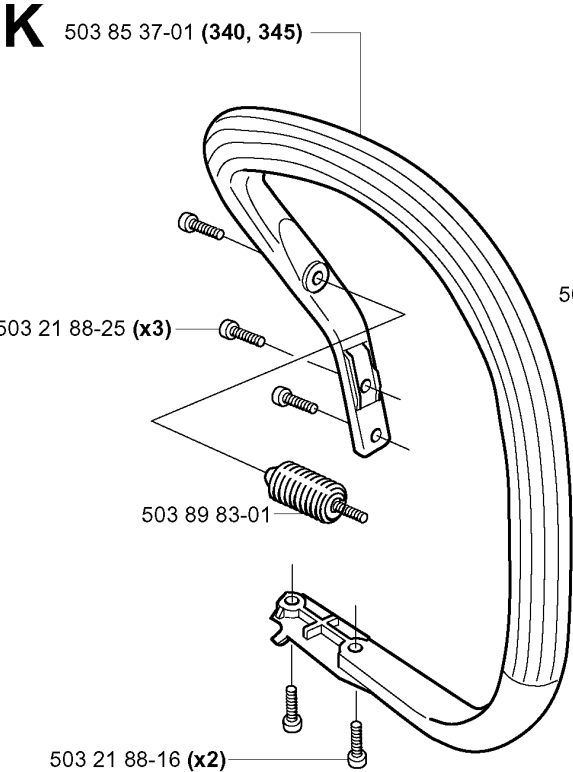

HANDLE

340 EPA, 2004-03

Part No	Description	Remark	QTY KIT
503 21 88-16	SCREW IHSCFT		2
503 21 88-16	SCREW IHSCFT		2
503 21 88-25	SCREW IHSCFT		3
503 21 88-25	SCREW IHSCFT		3
503 85 37-01	FRONT HANDLE	340, 345	1
503 89 83-01	ANTIVIBRATION ELEMENT		1
503 89 83-01	ANTIVIBRATION ELEMENT		1
503 90 93-01	HANDLE	350	1
503 92 24-01	SPACER		1

L

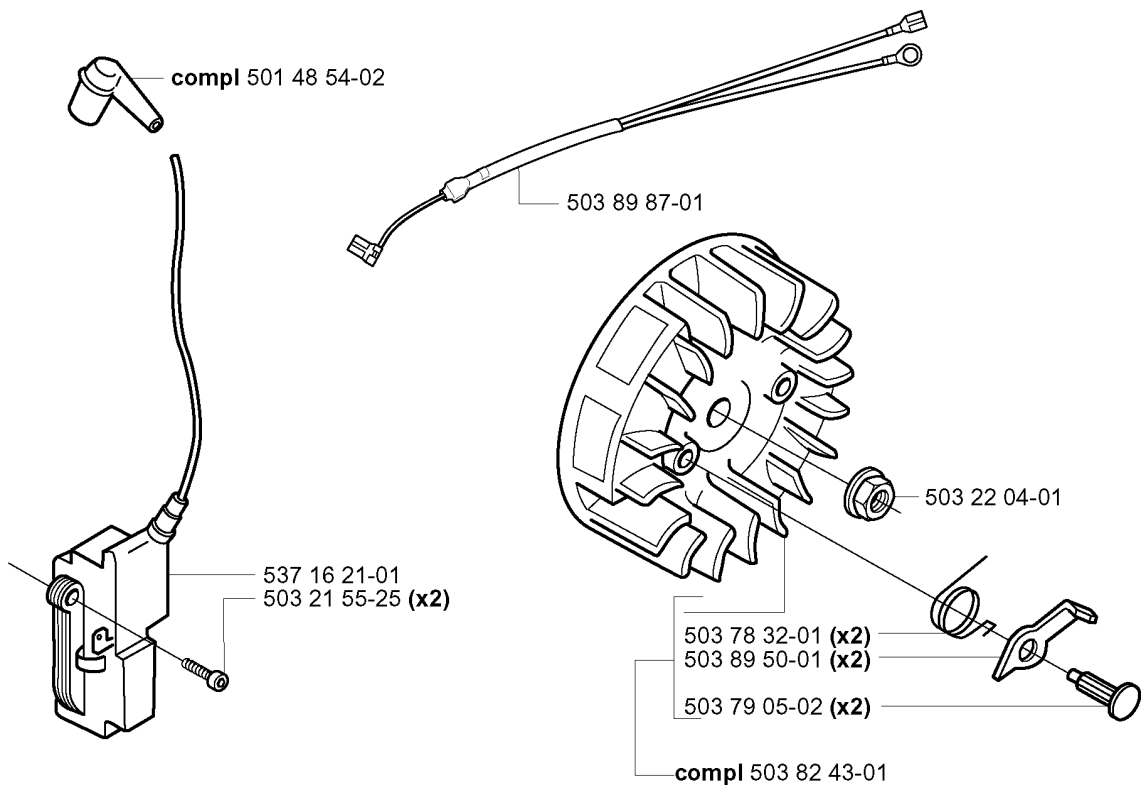

IGNITION SYSTEM

340 EPA, 2004-03

Part No	Description	Remark	QTY KIT
501 48 54-02	SPARK PLUG CAP		1
503 21 55-25	SCREW IHSCFT		2
503 22 04-01	NUT		1
503 78 32-01	SPRING		2
503 79 05-02	RIVET		2
503 82 43-01	FLYWHEEL		1
503 89 50-01	STARTER PAWL		2
503 89 87-01	WIRING ASSY		1
537 16 21-01	IGNITION SYSTEM		1

F *compl 503 86 27-03 (EU) 350

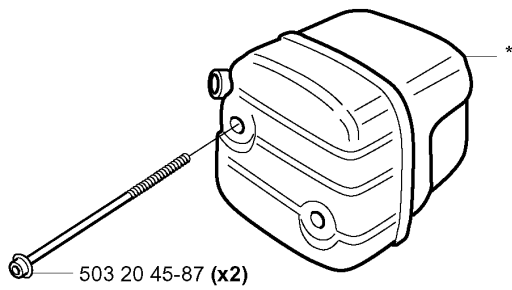

*compl 503 87 96-02 (FG) 340, 345

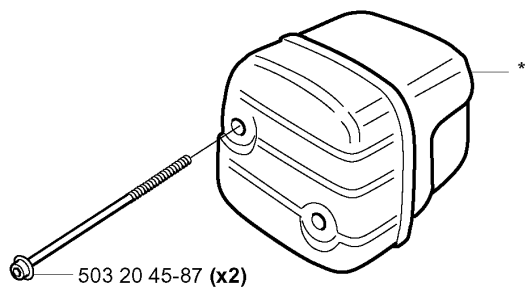

*compl 503 86 28-03 (DF) 340, 345, 350

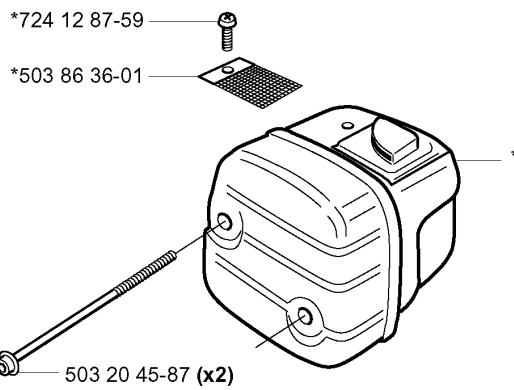

MUFFLER

340 EPA, 2004-03

Part No	Description	Remark	QTY KIT
503 20 45-87	SCREW IHSCFM		2
503 20 45-87	SCREW IHSCFM		2
503 20 45-87	SCREW IHSCFM		2
503 86 27-03	MUFFLER ASSY	(EU) 350	1
503 86 28-03	MUFFLER ASSY	(DF) 340, 345, 350	1
503 86 36-01	SPARK ARRESTOR SCREEN		1
503 87 96-02	MUFFLER ASSY	(FG) 340, 345	1
724 12 87-59	SCREW CRPANM		1

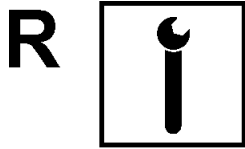

Up to 030103001 Only EPA (350)

***compl 503 89 99-71 (350)**
Correction: 503 86 99-71

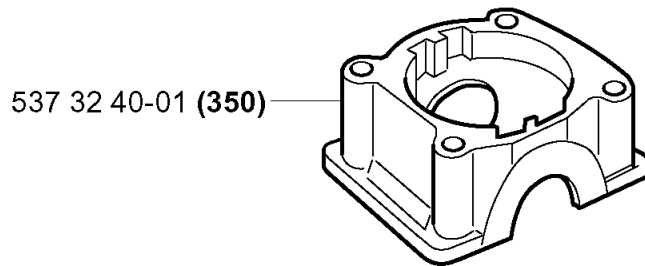
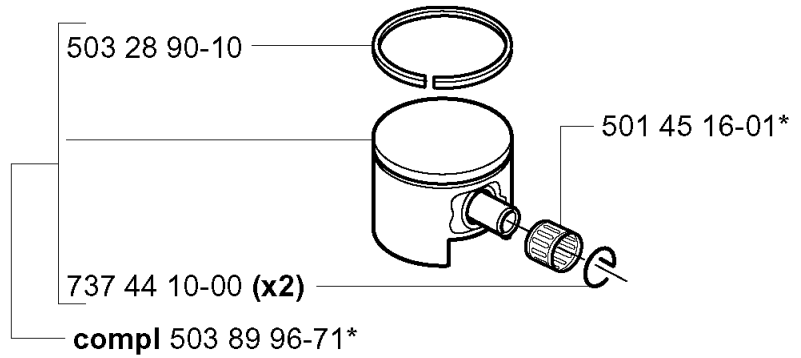
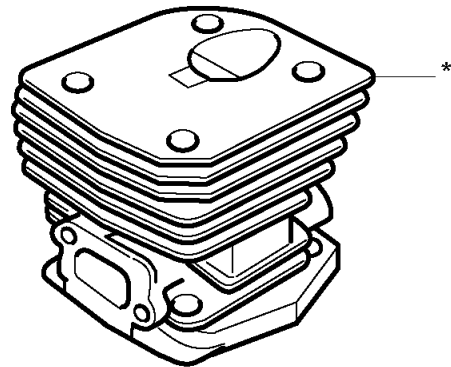

SERVICE UPDATES

340 EPA, 2004-03

Part No	Description	Remark	QTY KIT
503 85 99-01	RECOIL SPRING		1
503 87 63-01	STARTER PULLEY		1
503 89 07-02	HUB CAP		1
503 92 60-01	COVER PLATE		2



Up to 030103001 Only EPA (350)

***compl 503 89 99-71 (350)**
Correction: 503 86 99-71

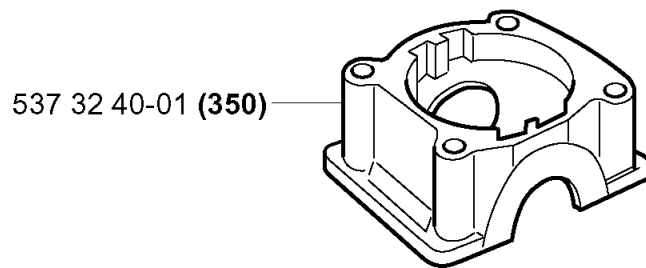
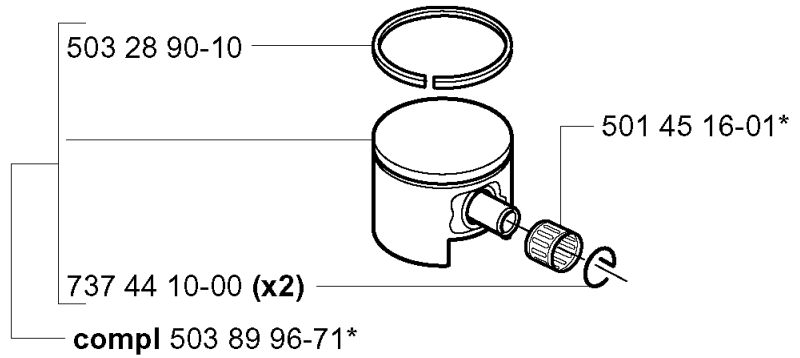
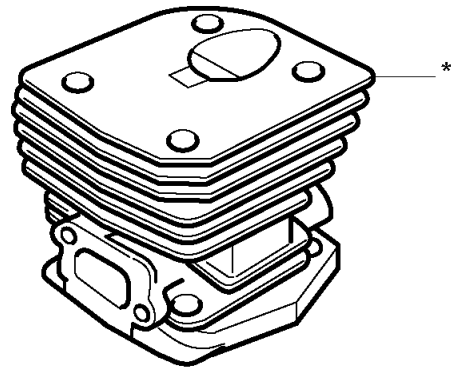

SERVICE UPDATES

340 EPA, 2004-03

Part No	Description	Remark	QTY KIT
501 45 16-01	NEEDLE BEARING		1
503 28 90-10	PISTON RING		1
503 86 99-71	CYLINDER ASSY	CORRECTION:	1
503 89 96-71	PISTON ASSY		1
537 32 40-01	BEARING COVER	350	1
737 44 10-00	SNAP RING		2

M

*compl 537 10 47-02

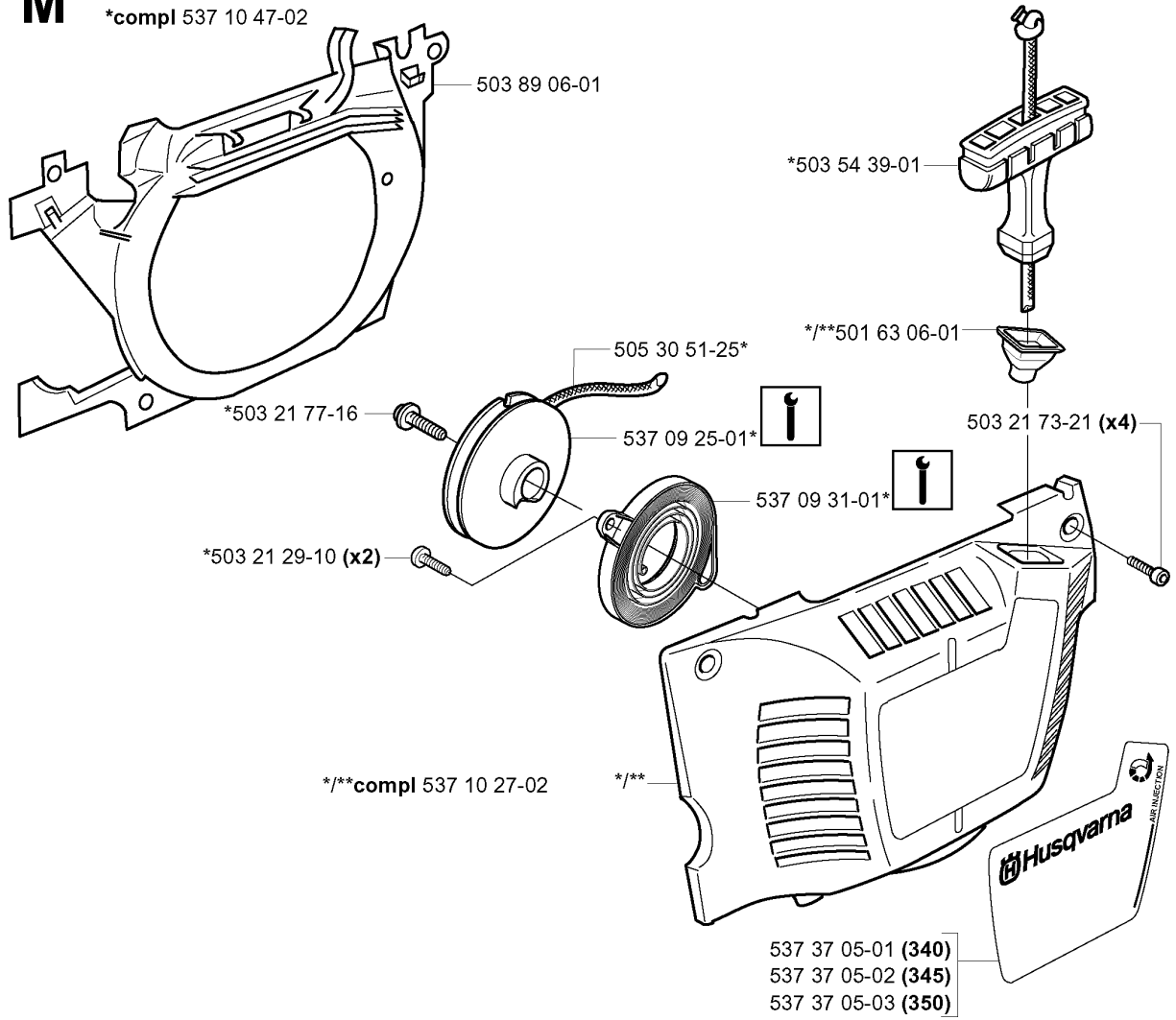

STARTER

340 EPA, 2004-03

Part No	Description	Remark	QTY KIT
501 63 06-01	REINFORCEMENT SLEEVE		1
503 21 29-10	SCREW CCRPANT		2
503 21 73-21	SCREW CIHSCTO		4
503 21 77-16	SCREW IHSCT		1
503 54 39-01	STARTER HANDLE		1
503 89 06-01	AIR CONDUCTOR		1
505 30 51-25	STARTER CORD		1
537 09 25-01	STARTER PULLEY		1
537 09 31-01	SPRING CASSETTE ASSY		1
537 10 27-02	STARTER HOUSING		1
537 10 47-02	STARTER ASSY		1
537 37 05-01	LABEL	340	1
537 37 05-02	LABEL	345	1
537 37 05-03	LABEL	350	1